

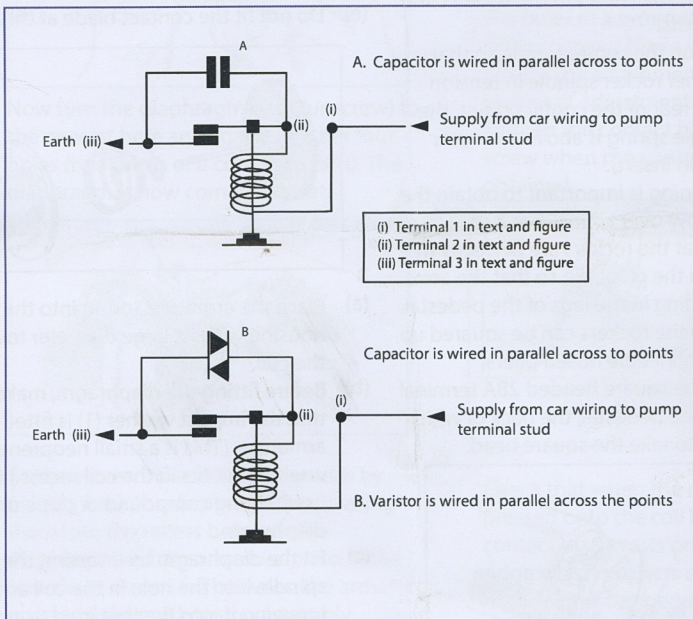

Servicing Guide

IMPORTANT: Read Before Commencing Work

Pump Electrical Circuits - Schematic



Electrical Fuel Pump

Note: The steel pin which secures the rocker mechanism to the pedestal is specially hardened and must not be replaced by anything other than a genuine SU part.

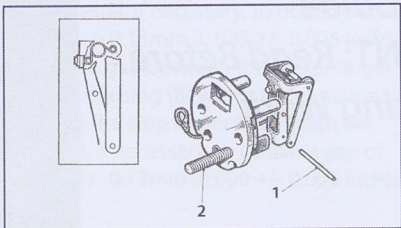

1

- (a) Invert the pedestal and fit the rocker assembly to it by pushing the steel pin (1) through the small holes in the rockers and pedestal struts.
- (b) Then position the centre toggle so that, with the inner rocker spindle in tension against the rear of the contact point, the centre toggle spring is above the outer spindle (as in insert).
- (c) This positioning is important to obtain the correct 'throw-over action'. It is also essential that the rockers are perfectly free to swing on the pivot pin so that the arms are not binding in the legs of the pedestal.
- (d) If necessary the rockers can be squared up with a pair of needle nosed pliers.
- (e) Assemble the square headed 2BA terminal stud (2) to the pedestal, the back of which is recessed to take the square head.

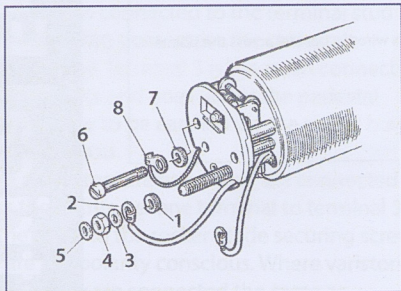

2

- (a) Assemble the 2BA washer (1) and put the terminal stud through the 2BA terminal tag (2), then fit the lead washer (3) and the coned

nut with the coned face to the lead washer. (This makes better contact than an ordinary flat washer and nut).

- (b) Tighten the 2BA nut and finally add the end-cover seal washer (5).
- (c) Assemble the pedestal to the coil housing (see figure 2) by fitting the 2BA pedestal screws (6), and ensure that the spring washer (7) on the left-hand (9 o'clock position) is between the pedestal and earthing tag (8).
- (d) Tighten the screws, taking care to prevent the earthing tag from turning, as this will strain or break the earthing flex.
- (e) Do not fit the contact blade at this stage.

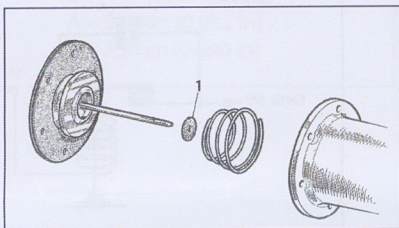

3

- (a) Place the armature spring into the coil housing with its large diameter towards the coil.
- (b) Before fitting the diaphragm, make sure that the impact washer (1) is fitted to the armature. (This is a small neoprene washer that fits in the coil recess.) Do not use jointing compound or dope on the diaphragm.
- (c) Fit the diaphragm by inserting the spindle into the hole in the coil and screwing it into the threaded trunnion in the centre of the rocker assembly.
- (d) Screw in the diaphragm until the rocker will not 'throw-over'; this must not be confused with jamming the armature on the coil housing integral steps.
- (e) On later type rocker mechanisms with adjustable fingers, fit the contact blade and adjust the finger settings, then carefully remove the contact blade.

4

- (a) Holding the coil housing assembly in the left hand in an approximately horizontal position, push the diaphragm spindle in with the thumb of the right hand, pushing in firmly but steadily.
- (b) Unscrew the diaphragm pressing and releasing with the thumb of the right hand until the rocker just 'throws-over'.

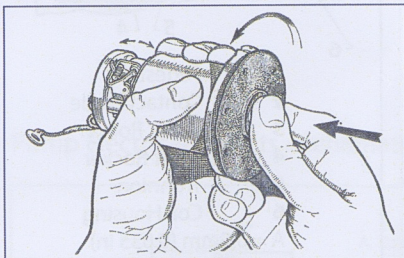

- (c) Now turn the diaphragm back (unscrew) to the nearest hole and again a further four holes (two thirds of a complete turn). The diaphragm is now completely set.

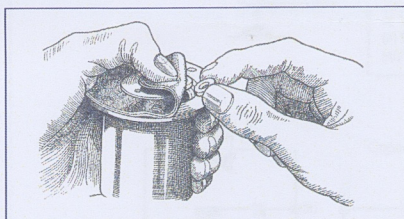

5

- (a) Fit the eleven brass armature guides by turning back the diaphragm and placing them into the recess between the diaphragm and the armature plate. Make sure these do not fall between the armature plate and the coil housing assembly.

6

- (a) Fit the contact blade (2) and coil lead (1) to the pedestal (3) with the BA washer and screw. Where a diode resistor is fitted it is in parallel with the coil connections. This component is polarity conscious and therefore all connections must be correctly made. A varistor, where fitted, is not polarity conscious.

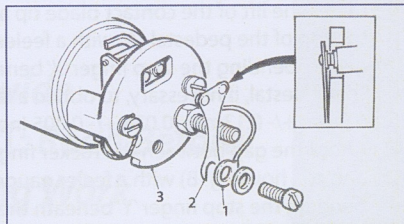

- (b) Adjust the contact blade so that the contact points are a little above the contact points on the rocker when the points are closed, also that when of the contact points make or break, one pair of the points wipes over the centre line of the other in a symmetrical manner. As the contact blade is provided with a slot for the attachment screw, some degree of adjustment is possible.
- (c) Tighten the contact blade attachment screw when the contact setting is obtained.

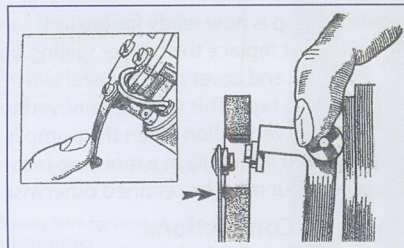

7

- (a) Check that when the outer rocker is pressed onto the coil housing, the contact blade rests on the narrow rib or ridge which projects slightly above the main face of the pedestal. If it does not, slacken the contact blade attachment screw, swing the blade clear of the pedestal, and bend it downwards a sufficient amount so that when repositioned it rests against the rib lightly. Over-tensioning of the blade will restrict the travel of the rocker mechanism.

